

**VT6DCC - 038 - 028 - 008 - 1 R 00 - A 1 - 00 - \***

**Series**

**Cam ring for "P1"**

Volumetric displacement cm<sup>3</sup>/rev (in<sup>3</sup>/rev)

*014/B14 = 47.6 (2.90)	035/B35 = 111.0 (6.77)
017/B17 = 58.2 (3.55)	038/B38 = 120.3 (7.34)
020/B20 = 66.0 (4.03)	042/B42 = 136.0 (8.30)
024/B24 = 79.5 (4.85)	045/B45 = 145.7 (8.89)
028/B28 = 89.7 (5.47)	050/B50 = 158.0 (9.64)
031/B31 = 98.3 (6.00)	061/B61 = 190.5 (11.62)

\*'0' - Uni-directional    'B' - Bi-directional

**Cam ring for "P2" & "P3"**

Volumetric displacement cm<sup>3</sup>/rev (in<sup>3</sup>/rev)

*003/B03 = 10.8 (0.66)	015/B15 = 50.5 (3.08)
005/B05 = 17.2 (1.05)	017/B17 = 58.3 (3.56)
006/B06 = 21.3 (1.30)	020/B20 = 63.8 (3.89)
008/B08 = 26.4 (1.61)	022/B22 = 70.3 (4.29)
010/B10 = 34.1 (2.08)	025/B25 = 79.3 (4.84)
012/B12 = 37.1 (2.26)	028/B28 = 88.8 (5.42)
014/B14 = 46.0 (2.81)	031/B31 = 100.0 (6.10)

\* '0' - Uni-directional    'B' - Bi-directional

**Modifications**

**Mounting w/connection variables**

SAE	P1 = 1¼" S = 4" P2 = 1"			
	UNC		Metric	
P3	1"	3/4"	1"	3/4"
Code	00	01	M0	M1

**Seal class**

1 - S1 (for mineral oil)  
4 - S4 (for fire resistant fluids)  
5 - S5 (for mineral oil and fire resistant fluids)

**Design letter**

**Porting combination (see page CI-1-4,5)**

00 = Standard

**Direction of rotation (view on shaft end)**

R - Clockwise  
L - Counter-clockwise

**Type of Shaft**

1 - Keyed (no SAE)  
2 - Keyed (SAE CC)  
3 - Splined (SAE C)  
4 - Splined (SAE CC)  
6 - Splined (no SAE)



## OPERATING CHARACTERISTICS - TYPICAL (24 cST) (Input power p (KW) for one cartridge only)

Pressure port	Series	Volumetric Displacement Vp		Flow q & n = 1500 rpm						Input power p & n = 1500 rpm					
		in <sup>3</sup> /rev	cm <sup>3</sup> /rev	p = 0 bar (0 psi)		p = 140 bar (2000 psi)		p = 240 bar (3500 psi)		p = 7 bar (100 psi)		p = 140 bar (2000 psi)		p = 240 bar (3500 psi)	
				gpm	lpm	gpm	lpm	gpm	lpm	hp	kw	hp	kw	hp	kw
P1	014	2.90	47.6	18.88	71.4	16.42	62.1	14.78	55.9	3.08	2.3	24.81	18.5	41.03	30.6
	017	3.55	58.2	23.1	87.3	20.6	78.0	18.99	71.8	3.35	2.5	29.77	22.2	49.62	37.0
	020	4.00	66.0	26.19	99.0	23.73	89.7	22.08	83.5	3.75	2.8	33.39	24.9	55.92	41.7
	024	4.80	79.5	31.56	119.3	29.10	110.0	27.46	103.8	4.02	3.0	39.69	29.6	66.78	49.8
	028	5.50	89.7	35.58	134.5	33.12	125.2	31.48	119.0	4.29	3.2	44.52	33.2	74.96	55.9
	031	6.00	98.3	39.00	147.5	36.53	138.1	34.89	131.9	4.42	3.3	48.54	36.2	81.80	61.0
	035	6.80	111.0	44.04	166.5	41.58	157.2	39.94	151.0	4.69	3.5	54.58	40.7	92.13	68.7
	036	7.30	120.3	47.72	180.4	45.26	171.1	43.62	164.9	4.96	3.7	58.87	43.9	99.64	74.3
	042 <sup>1)</sup>	8.30	136.0	53.96	204.0	51.50	194.7	49.86	188.5	5.36	4.0	66.25	49.4	112.24	83.7
	045 <sup>1)</sup>	8.89	145.7	57.80	218.5	55.34	209.2	53.70	203.0	5.50	4.1	70.81	52.8	120.02	89.5
	050 <sup>1,2)</sup>	9.64	158.0	62.69	237.0	60.23	227.7	59.25	224.0	5.90	4.4	76.44	57.0	113.98	85.0
	061 <sup>1,3)</sup>	11.62	190.5	76.25	285.7	73.54	278.0	--	--	6.16	4.6	81.26	60.6	--	--
	P2 & P3	003	0.66	10.8	4.29	16.2	2.96	11.2	2.04	7.7	1.74	1.3	7.11	5.3	11.22
005		1.05	17.2	6.83	25.8	5.50	20.8	4.57	17.3	1.88	1.4	10.06	7.5	16.36	12.2
006		1.30	21.3	8.44	31.9	7.11	26.9	6.19	23.4	2.01	1.5	11.94	8.9	19.71	14.7
008		1.61	26.4	10.48	39.6	9.15	34.6	8.22	31.1	2.15	1.6	14.35	10.7	22.93	17.7
010		2.08	34.1	13.52	51.1	12.19	46.1	11.26	42.6	2.28	1.7	18.64	13.4	29.90	22.3
012		2.26	37.1	14.71	55.6	13.36	50.6	12.46	47.1	2.28	1.7	19.31	14.4	32.32	24.1
014		2.81	46.0	18.25	69.0	16.93	64.0	16.00	60.5	2.55	1.9	23.60	17.6	39.56	29.5
015		3.08	50.5	20.00	75.6	18.73	73.2	19.02	67.5	2.68	2.0	25.61	19.1	42.91	32.0
017		3.56	58.3	23.12	87.4	21.79	82.4	20.87	78.9	2.82	2.1	29.37	21.9	49.48	36.9
020		3.89	63.8	25.32	95.7	23.99	90.7	23.07	87.2	2.95	2.2	31.92	23.8	53.91	40.2
022		4.29	70.3	27.88	105.4	26.56	100.4	25.63	96.9	3.08	2.3	35.00	26.1	59.14	44.1
025		4.84	79.3	31.46	118.9	30.13	113.9	29.21	110.4	3.35	2.5	39.16	29.2	66.38	49.5
028 <sup>2)</sup>		5.42	88.8	35.24	133.2	33.92	128.2	33.28	125.8	3.75	2.8	43.85	32.7	65.04	48.5
031 <sup>2)</sup>	6.10	100.0	39.68	150.0	38.35	145.0	37.72	142.6	3.75	2.8	48.95	36.5	72.95	54.4	

1) 042-045-050-061=2200 RPM max.

2) 028-031- 050=210 bar (3000 psi) max. int.

3) 061 = 120 bar (1740 psi) max. int, 061 = 80 bar (1160 psi) cont.

## INTERNAL LEAKAGE (TYPICAL)

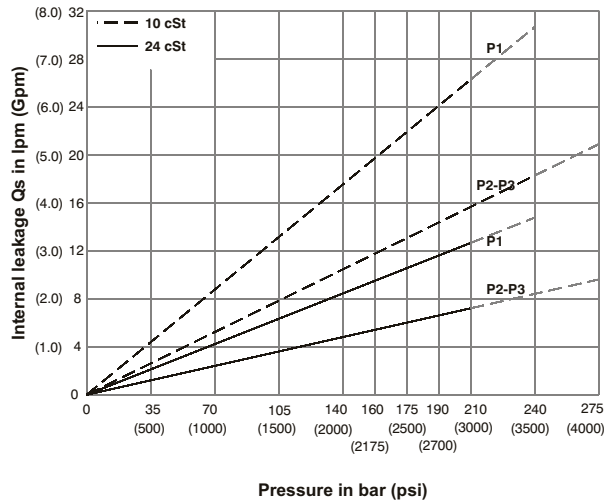

Total leakage is the sum of each section loss at its operating conditions.

## NOISE LEVEL (TYPICAL)

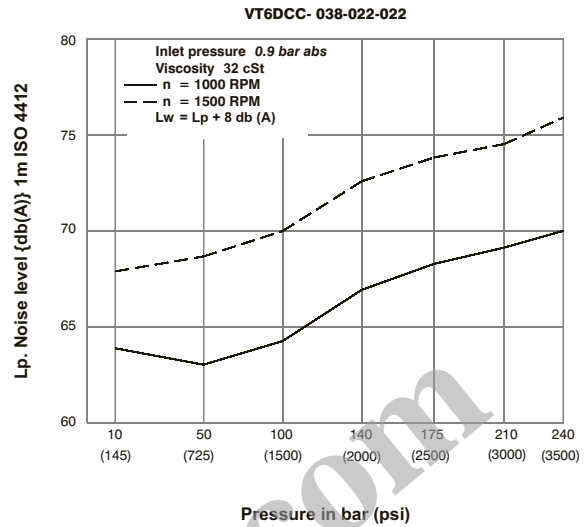

Triple pump noise level is given with each section discharging at the pressure noted on the curve.

## HYDROMECAHNICAL POWER LOSS (TYPICAL)

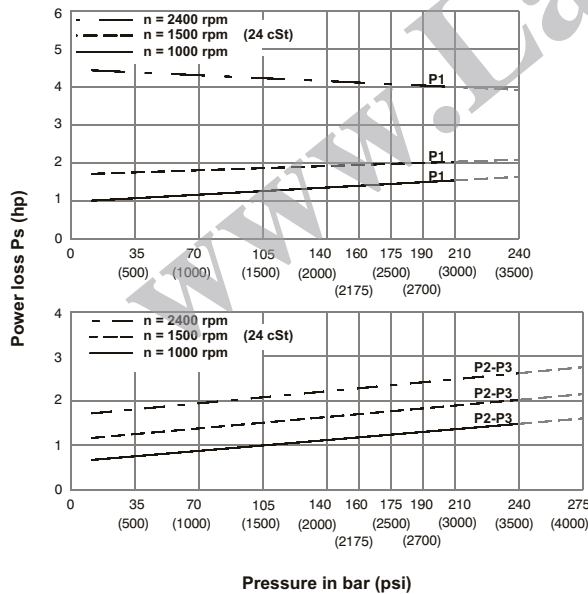

Total hydromechanical power loss is the sum of each section at its operating conditions.

## PERMISSIBLE RADIAL LOAD

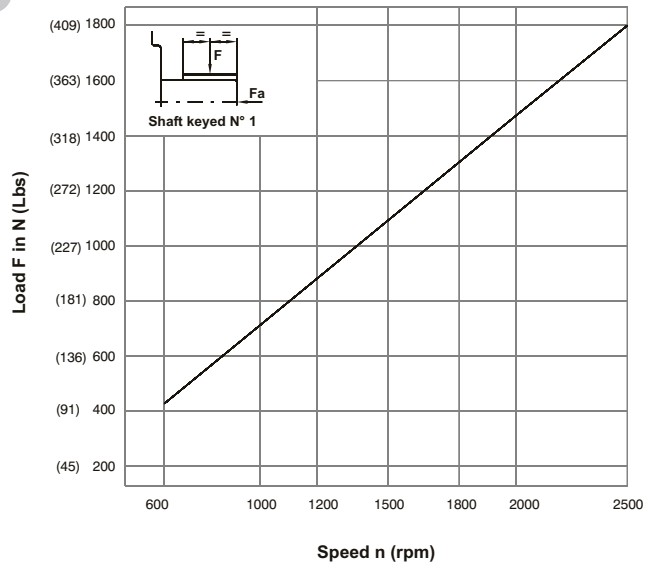

Maximum axial load permissible  $F_a=1200$  N (270 Lbs)

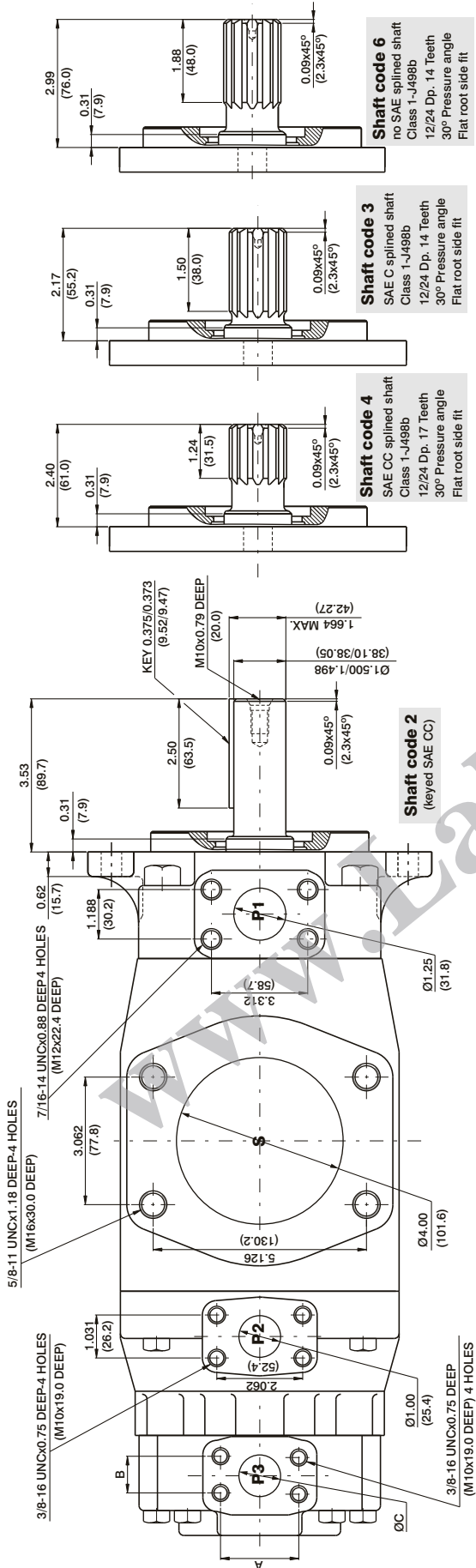

**Shaft code 6**  
no SAE splined shaft  
Class 1-J498b  
12/24 Dp. 14 Teeth  
30° Pressure angle  
Flat root side fit

**Shaft code 3**  
SAE C splined shaft  
Class 1-J498b  
12/24 Dp. 14 Teeth  
30° Pressure angle  
Flat root side fit

**Shaft code 4**  
SAE CC splined shaft  
Class 1-J498b  
12/24 Dp. 17 Teeth  
30° Pressure angle  
Flat root side fit

**Shaft code 2**  
(keyed SAE CC)

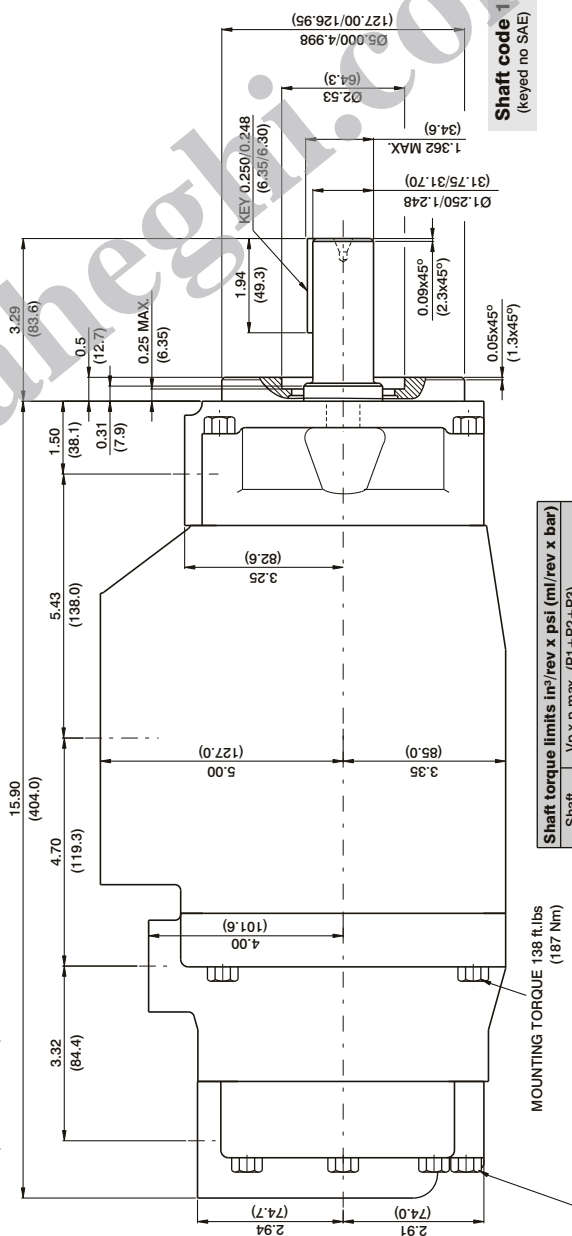
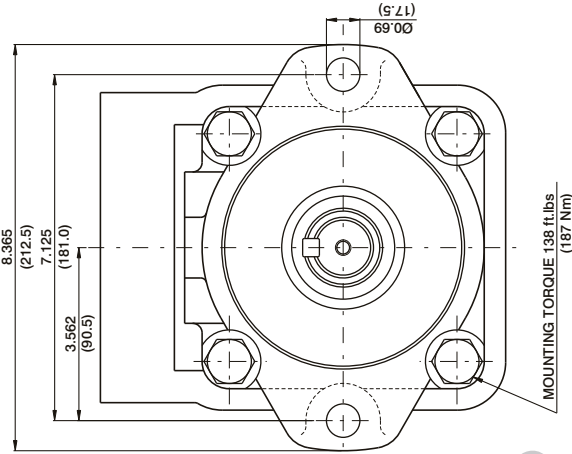

**Shaft code 1**  
(keyed no SAE)

PORT	CODE	A	B	C	
00 & M0	2.06	(52.4)	1.03	(26.2)	
P3	01 & M1	1.874	(47.6)	0.874	(22.2)
				0.75	(19.05)

Shaft	Vp x p max. (P1 + P2 + P3)
1	38299 (43240)
2	58901 (66500)
3	54027 (61200)
4	58901 (66500)

